



CHILLER MODEL: GD-100H-2C

230 Volt 1 Phase	
FLA	-
MCA	-
MOC	-

230 Volt 3 Phase	
FLA	446
MCA	494
MOC	686

460 Volt 3 Phase	
FLA	222
MCA	246
MOC	342

Dimensions ¹	91"W x 167"L x 95"H
Frame	Powder Coated Steel
Housing	Powder Coated Aluminum
Tank	900 Gallon Stainless Steel
Compressor HP	50 (x2)
Condenser	Air-Cooled Vertical Discharge
Process Pump HP	7.5
GPM @ 25 PSI	230
Connection Size	3" CTS Flange
Chiller Pump HP	5
Heat Exchanger	Stainless Steel Brazed Plate
Controls	Microprocessor w/ Comm.

Electrical Enclosure	NEMA 3R
Shipping Weight	8560 lbs
Decibels @ 10'	76
Refrigerant	R404a

Cooling Capacity by Leaving Fluid Temperature²

LFT	Btu/H	kW
20 °F	616,000	180.5
30 °F	778,000	228.0
40 °F	972,000	284.9

¹ Dimensions accurate for package chiller, remote condenser options will vary

² All capacities at 90 °F ambient

³ VFD available upon request

Chiller package consists of the following:

- Two complete refrigeration circuits
- Air-cooled condenser
- Process pump³
- Chiller pump
- Fluid bypass valve
- Freeze stat safety switch
- All insulated copper piping
- Powder coated steel frame
- Powder coated aluminum housing
- Semi-hermetic reciprocating compressors with capacity unloading
- Engineered high efficiency heat exchanger for maximum energy savings
- Insulated stainless steel glycol reservoir with baffle plate
- Microprocessor controller with communication
- ETL (UL508) listed complete control panel with single point electrical connection, breakers, starters & safety switches
- CTS flange glycol supply and return connections
- Louvered aluminum access panels for easy service & maintenance
- Factory run tested and fully charged with refrigerant

1 Year Parts and Labor Warranty

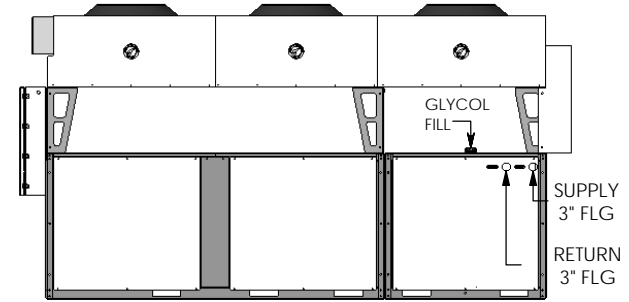
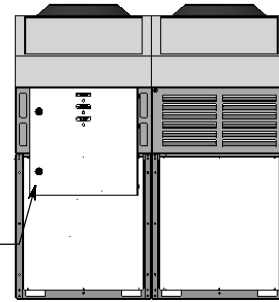
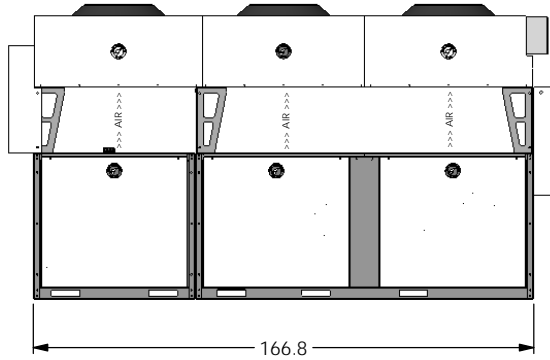
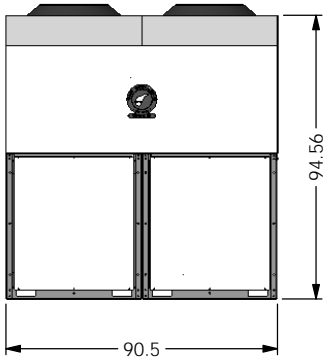
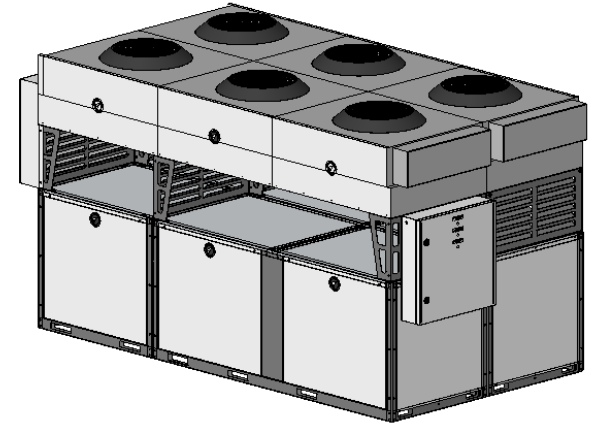
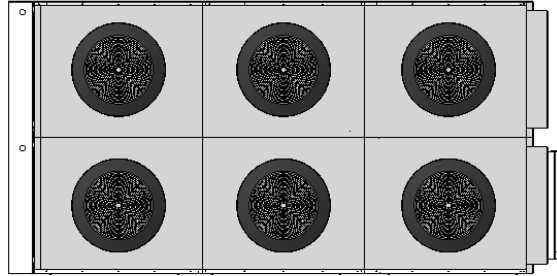
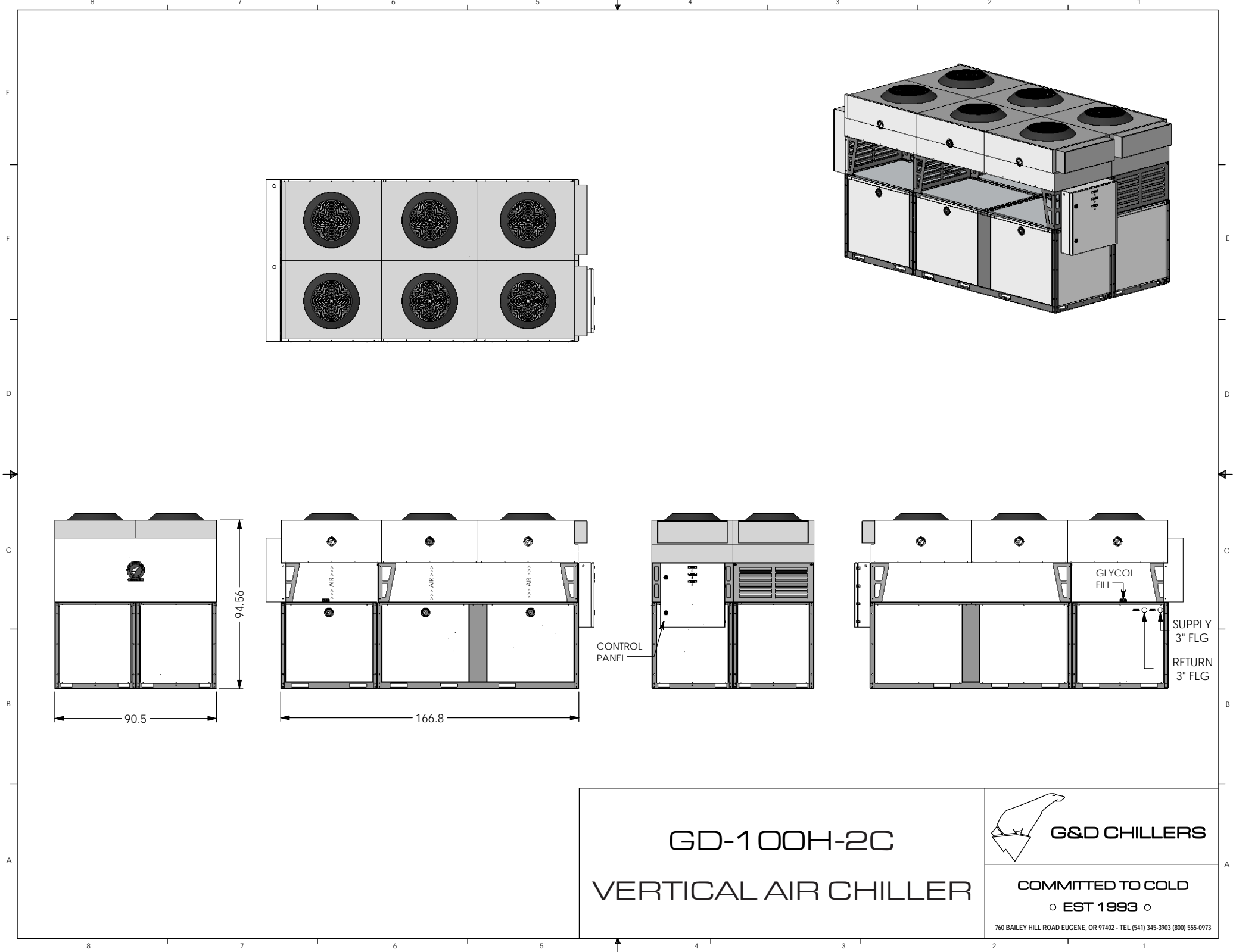

GD-100H-2C
VERTICAL AIR CHILLER



G&D CHILLERS

COMMITTED TO COLD
EST 1993

760 BAILEY HILL ROAD EUGENE, OR 97402 - TEL (541) 345-3903 (800) 555-0973