



## HEATER MODEL: **GD-12.5**

230 Volt 1 Phase	
FLA	-
MCA	-
MOC	-

230 Volt 3 Phase	
FLA	38
MCA	45
MOC	45

460 Volt 3 Phase	
FLA	17
MCA	22
MOC	25

Dimensions	32"W x 48"L x 40"H
Frame	Powder Coated Steel
Housing	Stainless Steel
Tank	30 Gallon Stainless Steel
Glycol Pump HP	0.75
GPM @ 25 PSI	25
Connection Size	0.75" Brass Quick Connects (x4)
Controls	Single Stage Digital

Heater kW	12.5
Electrical Enclosure	NEMA 3R
Shipping Weight	670 lbs
Decibels @ 10'	60
Heating Capacity (Btu/H)	42,700

### *Heater package consists of the following:*

- Low watt density heating element specifically designed for glycol
- Glycol pump with fluid bypass valve, enabling incorporation into existing chilling system
- Heavy duty rubber-on-steel casters for easy portability
- Powder coated steel frame
- Stainless steel housing
- NEMA 3R digital temperature controller for simple operation in damp environments
- Brass quick connects for heating up to 4 tanks at once without loss of glycol
- Insulated stainless steel glycol reservoir
- Full set of 20 ft. glycol hoses and 25 ft. power cord
- Complete stainless steel control panel with single point electrical connection, breakers, starters & safety switches

***1 Year Parts and Labor Warranty***

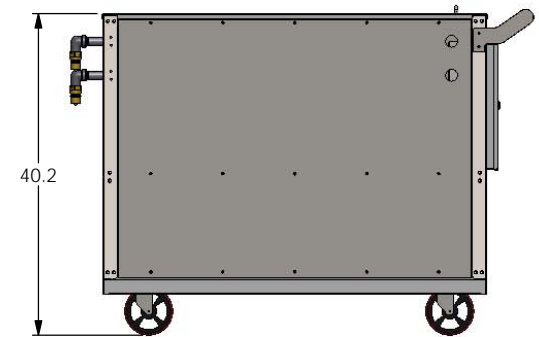
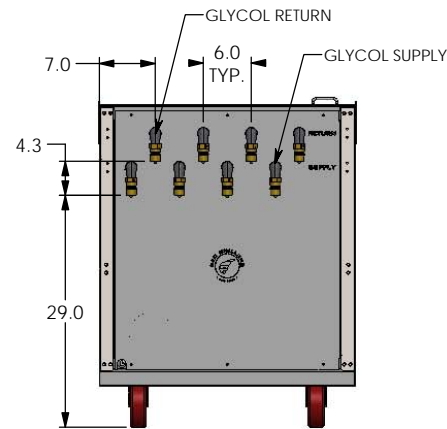
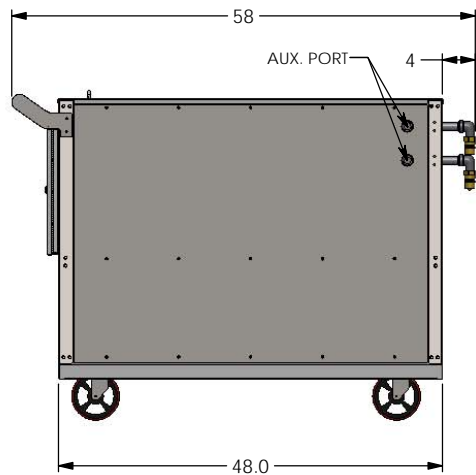
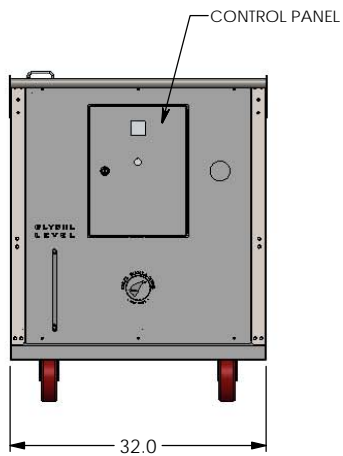
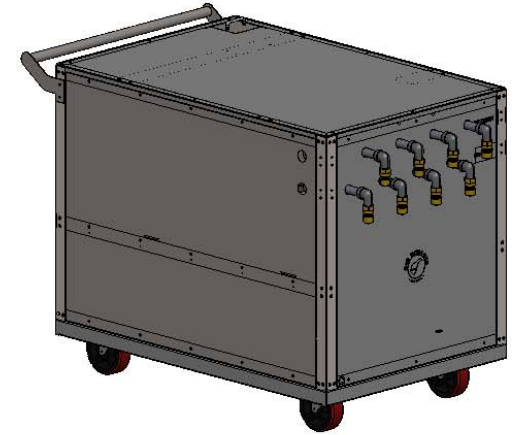
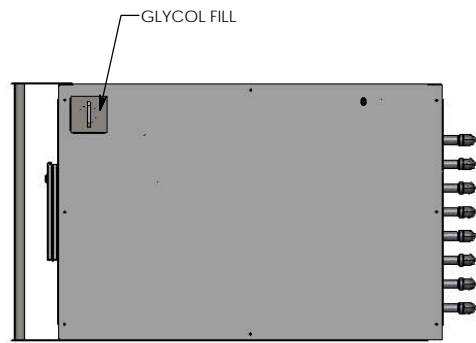

GD6 - 25KW  
PORTABLE HEATER

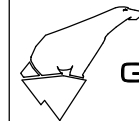

G&D CHILLERS

COMMITTED TO COLD

○ EST 1993 ○

3498 WEST FIRST, SUITE 1 EUGENE, OR 97402 - TEL (541) 345-3903 (800) 555-0973