



CHILLER MODEL: GD-7H

230 Volt 1 Phase	
FLA	-
MCA	-
MOC	-

230 Volt 3 Phase	
FLA	41
MCA	47
MOC	74

460 Volt 3 Phase	
FLA	16
MCA	19
MOC	30

Dimensions ¹	34"W x 61"L x 49"H
Frame	Powder Coated Steel
Housing	Powder Coated Aluminum
Tank	60 Gallon Stainless Steel
Compressor HP	7
Condenser	Air-Cooled
Glycol Pump HP	1.5
GPM @ 25 PSI	40
Connection Size	1" FPT
Heat Exchanger	Stainless Steel Brazed Plate
Controls	Single Stage Digital

Electrical Enclosure	NEMA 3R
Shipping Weight	1200 lbs
Decibels @ 10'	65
Refrigerant	R404a

Cooling Capacity by Leaving Fluid Temperature ²

LFT	Btu/H	kW
20 °F	41,395	12.1
30 °F	51,046	15.0
40 °F	61,824	18.1

¹ Dimensions accurate for package chiller, remote condenser options will vary

² All capacities at 90 °F ambient

³ VFD available upon request

Chiller package consists of the following:

- Complete refrigeration circuit
- Air-cooled condenser
- Glycol pump³
- Fluid bypass valve
- All insulated copper piping
- Powder coated steel frame
- Powder coated aluminum housing
- Insulated stainless steel glycol reservoir
- Engineered high efficiency heat exchanger for maximum energy savings
- Digital temperature controller
- ETL (UL508) listed complete control panel with single point electrical connection, breakers, starters & safety switches
- Brass ball valves for supply and return glycol connections
- Louvered aluminum access panels for easy service & maintenance
- Factory run tested and fully charged with refrigerant

2 Year Parts and 1 Year Labor Warranty

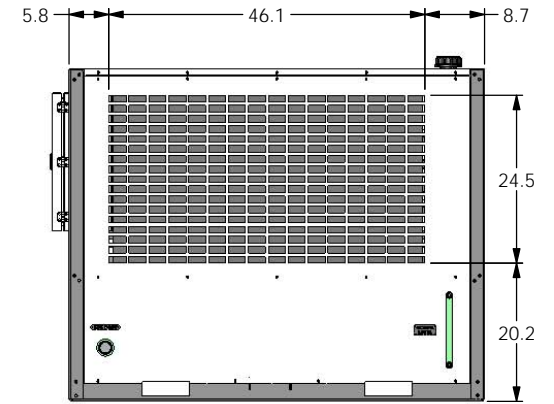
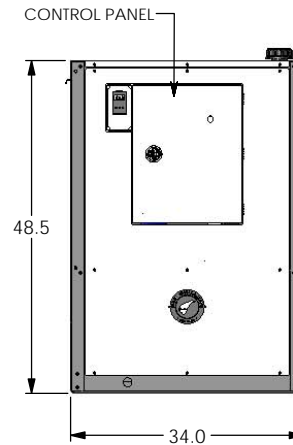
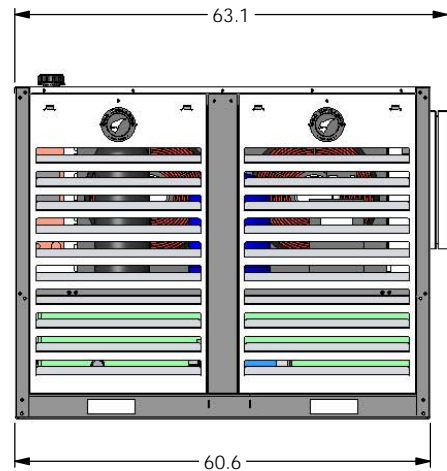
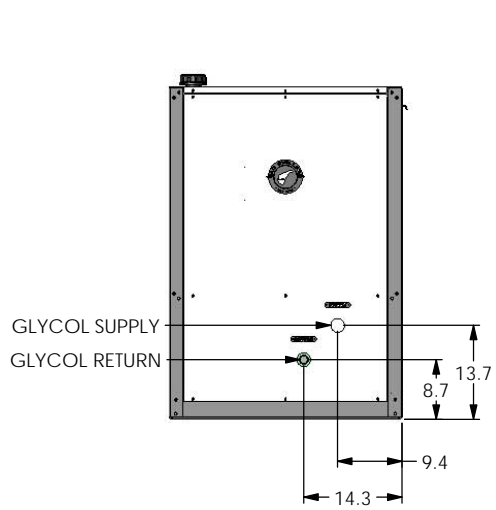
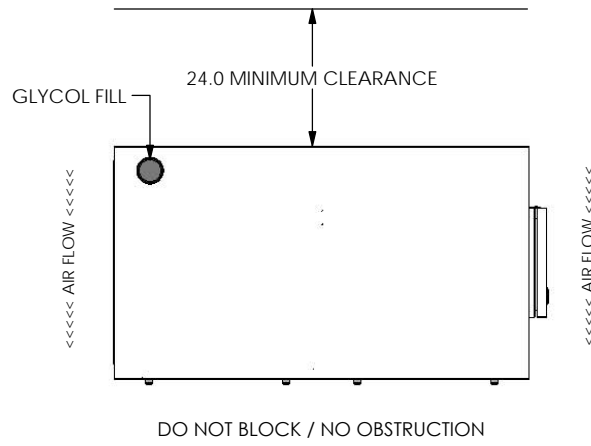
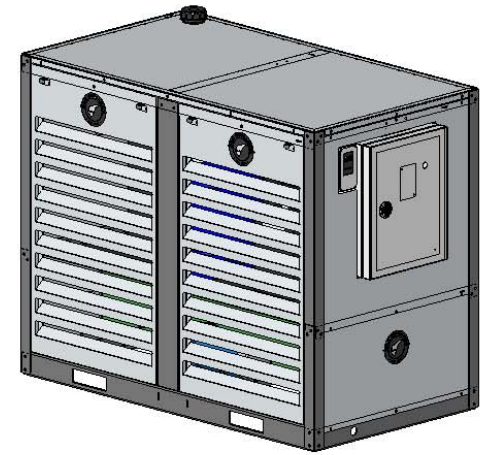

GD-5H/7H STATIONARY CHILLER

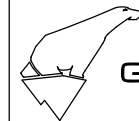

G&D CHILLERS

COMMITTED TO COLD

◦ EST 1993 ◦

760 BAILEY HILL ROAD EUGENE, OR 97402 · TEL (541) 345-3903 (800) 555-0973