

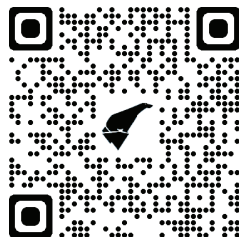

## GLYCOL HEATER SERIES

### INSTALLATION GUIDE USER MANUAL



---

GLYCOL HEATER SERIES  
©2021 G&D CHILLERS, INC.  
ALL RIGHTS RESERVED

# CONTENTS

- CONTACT INFORMATION & AFTERHOURS SUPPORT ..... 4
- INSTALLATION VIDEO LINKS..... 4
- GLYCOL HEATER DESCRIPTION ..... 5
- INSTALLATION REQUIREMENTS ..... 5
- PIPING RECOMMENDATIONS ..... 6
- START-UP INSTRUCTIONS .....11
- WARRANTY START-UP CHECKLIST .....12
- SEQUENCE OF OPERATION .....13
- MAINTENANCE..... 14
- TROUBLESHOOTING..... 15
- PROPYLENE GLYCOL CHART ..... 16
- WARRANTY STATEMENT ..... 17

---

## CONTACT INFORMATION & AFTERHOURS SUPPORT

### CONTACT INFORMATION

G&D Chillers, Inc.  
130 E 1st Ave  
Junction City OR, 97448

1.800.555.0973  
info@gdchillers.com  
Office Hours: 8 AM – 5 PM PST

### AFTERHOURS TECHNICAL SUPPORT

G&D Chillers offers 24/7 technical support. For emergency assistance after normal business hours, call the main office at 1.800.555.0973. The voicemail recording will provide contact information for the emergency on-call service technician.

### INSTALLATION VIDEO LINKS

Visit the following pages for installation video walk-throughs and FAQs:

[gdchillers.com/installation-videos/](http://gdchillers.com/installation-videos/)

[gdchillers.com/installation-videos/how-to-install-a-chiller](http://gdchillers.com/installation-videos/how-to-install-a-chiller)

[gdchillers.com/installation-videos/how-to-install-a-portable-fire-ice-chiller/](http://gdchillers.com/installation-videos/how-to-install-a-portable-fire-ice-chiller/)

[gdchillers.com/faq](http://gdchillers.com/faq)

#### **NOTICE: HEATER WARRANTY REQUIRES ACTIVATION**

To activate the heater parts and labor limited warranty, complete the Warranty Start-Up Checklist and return to G&D Chillers within 30 days.

## GLYCOL HEATER DESCRIPTION

### CIRCULATION PUMP

Base mounted end suction centrifugal pump. Impeller trimmed for 35% propylene glycol mixture.

### RESERVOIR TANK

Constructed stainless steel. Insulated with ½” closed cell foam insulation.

### SUPPLY & RETURN PIPING

Constructed of type M copper. Supply and return stainless steel manifold with auxiliary ports. Quick connect fittings provided for up to four connections. Liquid-filled pressure gauge for setting discharge pressure.

### DYNAMIC FLUID BYPASS VALVE

Allows for balancing of discharge pressure. Over pressure design allows circuiting back to tank without damage to system or pump. Copper and bronze construction.

### FRAME & HOUSING

Fully powder coated steel frame. Durable stainless-steel housing. Louvered access panel for easy service and maintenance. Standard units include industrial-grade casters for easy portability.

### POWER & CONTROLS

All power starting controls and safety/operating controls are mounted in a weather resistant steel NEMA 3R enclosure. Features include:

- Digital temperature controller
- Pump contactor and circuit breaker
- Heating element hi-temp limit
- Over-temperature shut down

### FACTORY TESTING

All heater units are leak checked and run tested at the factory, and verified to be in perfect working order prior to shipment.

## INSTALLATION REQUIREMENTS

**WARNING: OBEY ALL APPLICABLE LOCAL AND NATIONAL ELECTRIC CODES WHEN INSTALLING THIS EQUIPMENT**

1. The unit should sit on a solid level surface. A concrete pad is recommended.
2. Supply unit with the proper voltage and protect against power spikes. Use only copper wire. Size wire and according to any/all applicable local and national codes. Refer to chart to the right for proper torque values. Refer to spec sticker on control panel for all electrical ratings.
3. Install a plug that meets the electrical requirements of the system and the environmental requirements of the space where the system will be used. Must be installed by a qualified electrician.
4. Unit must be properly grounded.
5. Use only hubs or fittings that meet the environmental requirements where the system will be used.
6. On systems with three-phase pumps the rotation of the pump must be checked; clockwise from back of motor. If needed, correct phasing at the plug. Ensure that all receptacles where the system may be connected are phased the same.

TORQUE CHART	
Gauge	lbf-in
1000-500	550
500-4	500
350-6	375
250-6	375
4/0-6	275
2/0-14	120
#2-#3	50
#4-#6	45
#8	40
#10-#14	35

## PIPING RECOMMENDATIONS

**Heater** units are built with glycol supply and return stainless-steel manifolds fitted with male quick connect fittings. One set of hoses with female quick connect fittings are included. Additional hose sets are available for purchase. Male quick connects will be needed on tanks to connect with hose set.

Confirm **tank jackets** have been flushed of any debris before connecting to them for the first time.

Individual tank **temperature control package** should be installed at each vessel to maintain optimal conditions for each process being heated.

Always connect the **glycol supply** to the bottom fitting on the tank jacket and the return to the top. This allows any air in the jacket to be purged back to the heater reservoir and vented to the atmosphere.

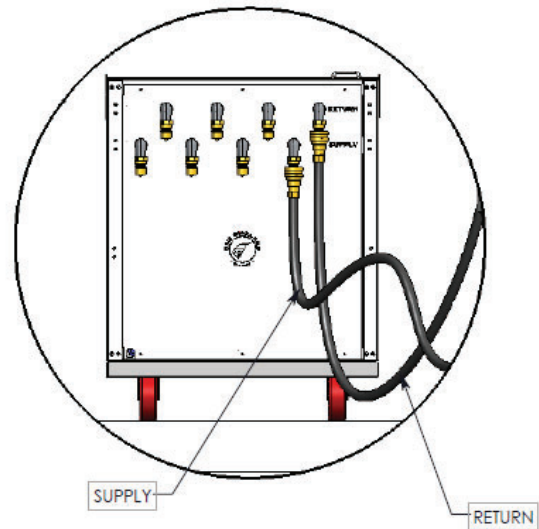

**Glycol pressure is adjustable: Verify tank jacket ratings before pressurizing piping** (pressure is pre-set at 20 PSI)

- Heater contains dynamic fluid bypass valve and pressure gauge on supply line
  - Bypass valve: Loosen packing nut and turn handwheel to adjust supply pressure
  - Retighten bypass valve packing nut once the pressure is set
- Do not connect hoses until gauge shows pressure within tank jacket ratings

Note: If using the optional auxiliary port connections, it is recommended that a **20 mesh Y-strainer** be included at the return connection.



REVISIONS		DATE	APPROVED
ZONE	REV.		
DESCRIPTION			

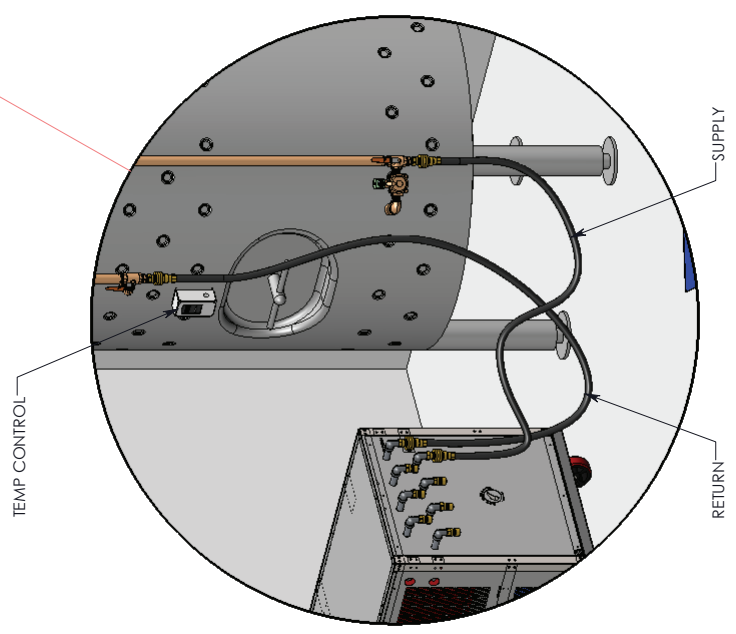
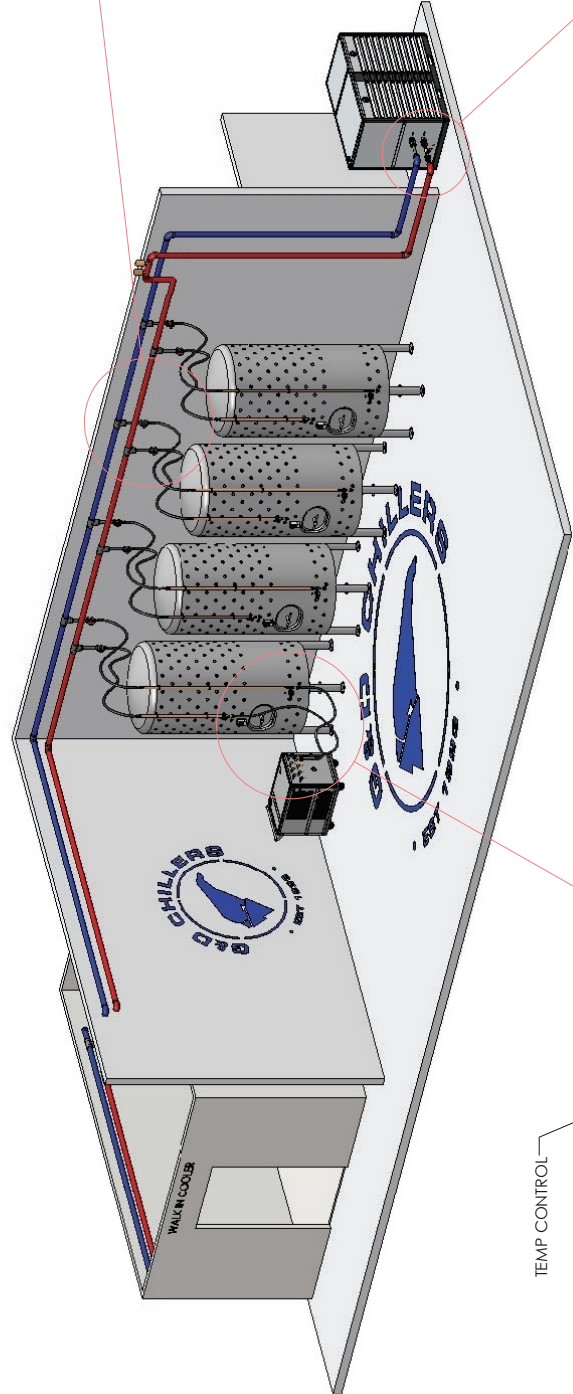
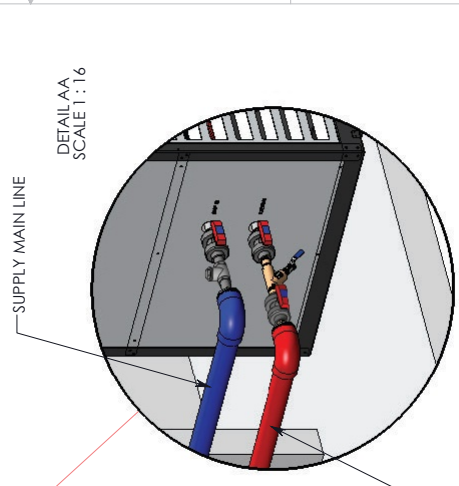
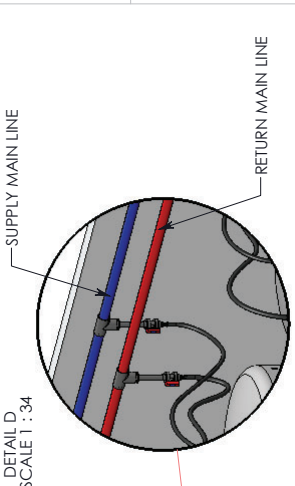

G&D CHILLERS

COMMITTED TO COLD

EST 1993

130 E 1ST AVE JUNCTION CITY OR, 97448 - TEL: (941) 346-3903 (800) 555-0973

# FIRE AND ICE TO EXISTING GLYCOL SYSTEM PIPING

DETAIL AA  
SCALE 1 : 16

DETAIL C.  
SCALE 1 : 26

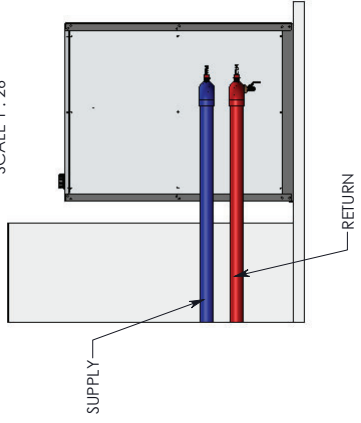

SUPPLY

RETURN

E

WALK IN COOLER

E

DETAIL AN  
SCALE 1 : 18

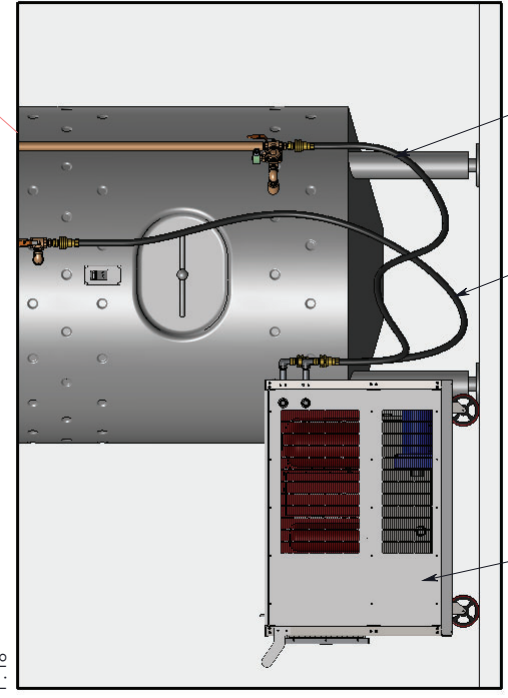

SUPPLY

RETURN

PORTABLE CHILLER & HEATER

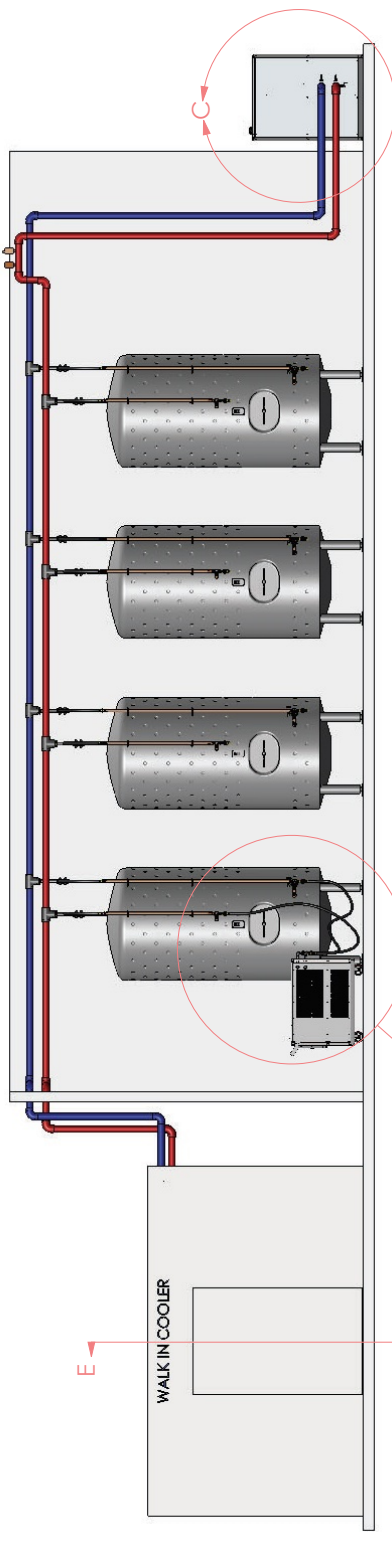

C

GLYCOL FAN COIL

SECTION EE  
SCALE 1 : 54

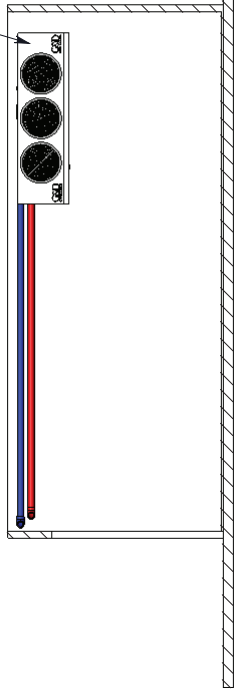

# FIRE AND ICE TO EXISTING GLYCOL SYSTEM PIPING

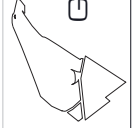

G&D CHILLERS

COMMITTED TO COLD

EST 1993

130 E 1ST AVE, JUNCTION CITY, OR 97448 • TEL: (941) 345-3903 • (800) 555-0973



DETAIL AF  
SCALE 1 : 32

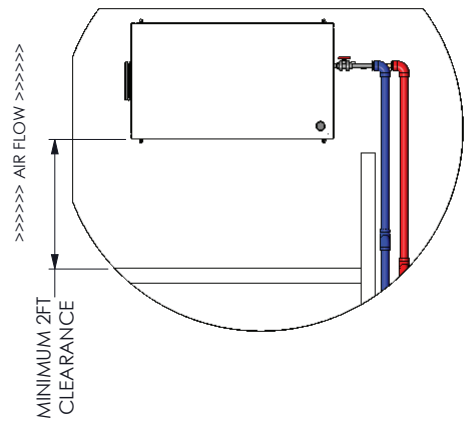
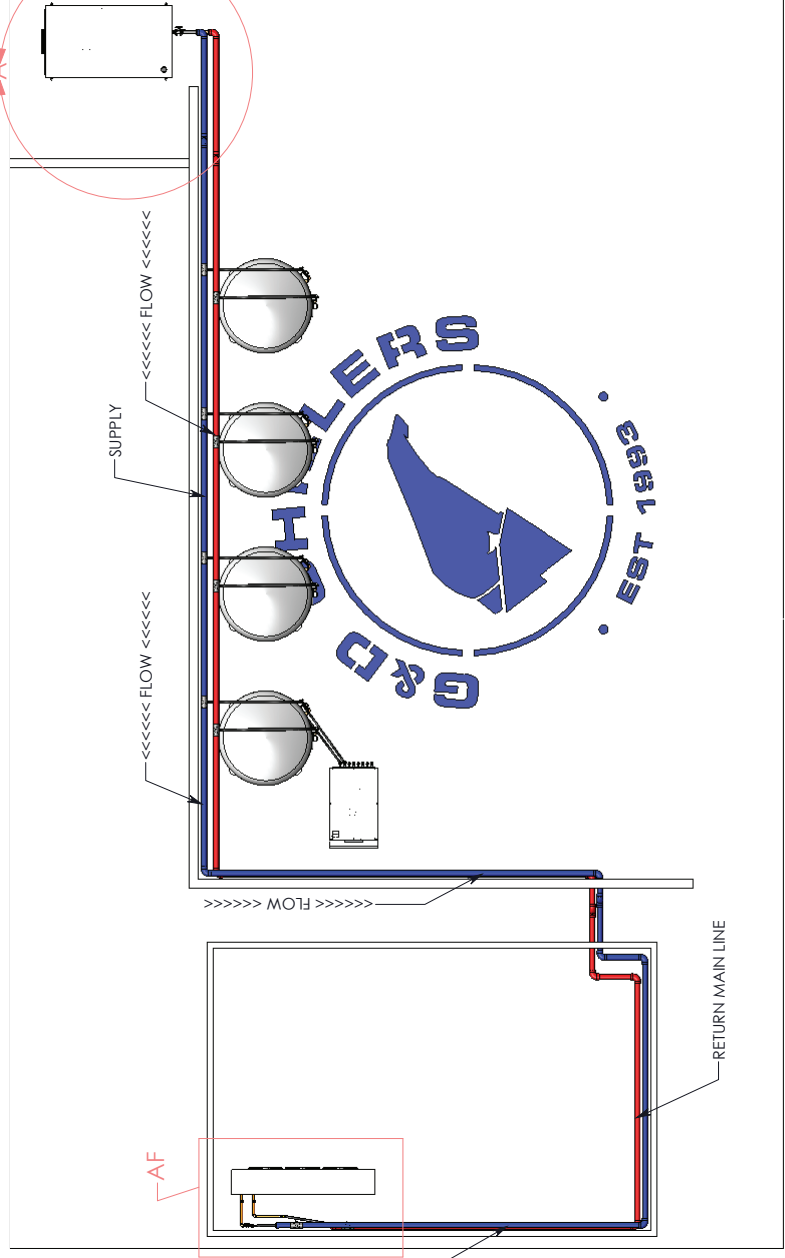
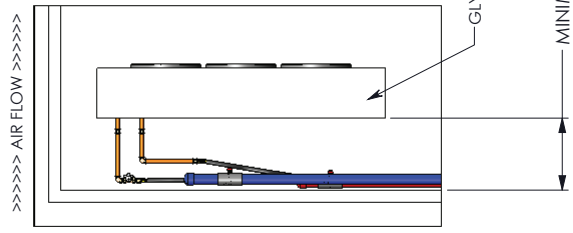

# FIRE AND ICE TO EXISTING GLYCOL SYSTEM PIPING

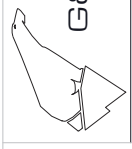

G&D CHILLERS

COMMITTED TO COLD  
EST 1993

130 E 1ST AVE, JUNCTION CITY, OR, 97448 • TEL: (541) 345-3903 (800) 555-0973

DETAIL A  
SCALE 1 : 40

DETAIL AJ  
SCALE 1 : 5

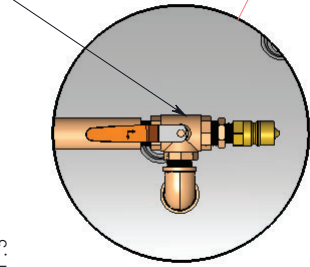

3-WAY BALL VALVE

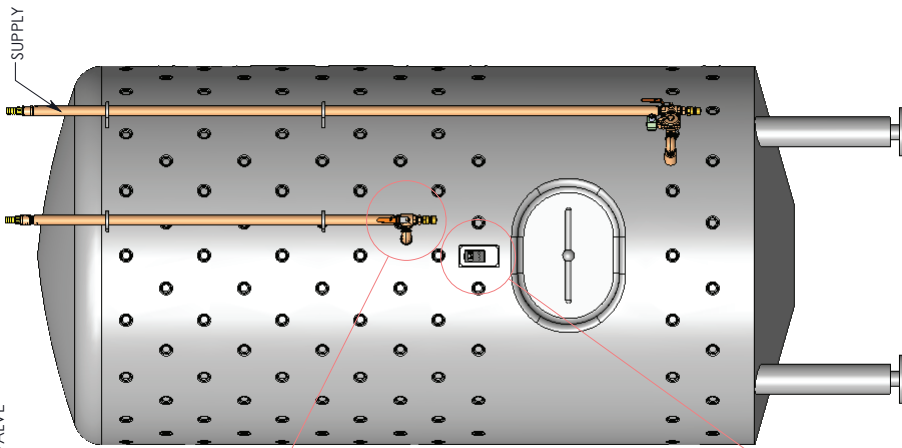

SUPPLY

RETURN

DETAIL AL  
SCALE 1 : 6

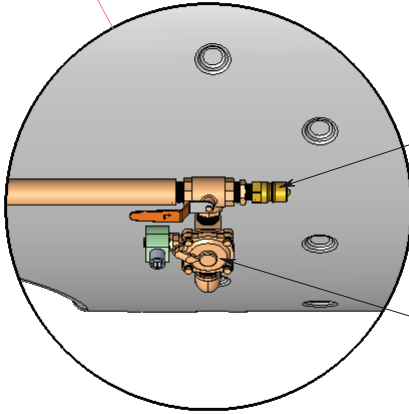

110 VOLT SOLENOID  
QUICK DISCONNECT

DETAIL AK  
SCALE 1 : 4

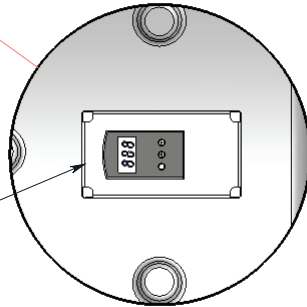

TEMP CONTROL

# FIRE AND ICE TO EXISTING GLYCOL SYSTEM PIPING

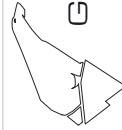

G&D CHILLERS

COMMITTED TO COLD

EST 1993

130 E. STAVE, JUNCTION CITY, OR, 97448 - TEL: (541) 345-3303 (800) 555-6973



Please view install videos online at [www.gdchillers.com/installation-videos](http://www.gdchillers.com/installation-videos)

### Glycol Heater Series Startup

1. **Be sure all pump isolation valves are open.** Connect to power.
2. Fill reservoir with heat transfer fluid (please ensure a 35% glycol mixture if your process utilizes a G&D Chillers cooling unit).
3. Confirm pump rotation direction if using 3 phase power.
4. Turn door switch to ON position.
5. Adjust set point using arrow keys on PM6 controller. Set point will appear in green, actual temperature is displayed in red.

**PLEASE VISIT GDCHILLERS.COM TO VIEW OUR INSTALLATION VIDEOS & FAQs**

\*G&D Chillers welcomes any and all questions or concerns. We can be reached at **800-555-0973** or **541-345-3903**

# WARRANTY START-UP CHECKLIST

Jobsite:				Tech Company:
Chiller Model:				Technician:
Chiller Serial #:				Start-Up Date:
<b>FOLLOWING START-UP OF CHILLER, PLEASE SEND A COPY OF COMPLETED FORM TO G&amp;D TECH SUPPORT</b>				
CLEARANCE AROUND CHILLER <small>(Include picture if necessary)</small>	FRONT:	BACK:	LEFT:	RIGHT:
GLYCOL/DYNALENE MIXTURE %				
GLYCOL/DYNALENE LEVEL (Reservoir % Full)				
PHASE/VOLTAGE				
VOLTAGE TO GROUND <small>(Note: High Leg to L2)</small>	L1:	L2:	L3:	
PUMP ROTATION				
GLYCOL PRESSURE				
	COMPRESSOR A	COMPRESSOR B	COMPRESSOR C	COMPRESSOR D
CRANK CASE HEATER ENERGIZED 4 HOURS				
COMPRESSOR OIL LEVEL				
MOTOR AMPS:	L1:	L1:	L1:	L1:
	L2:	L2:	L2:	L2:
	L3:	L3:	L3:	L3:
SUPERHEAT (°F) @ 30°F GLYCOL TEMP				
SUBCOOLING (°F) @ 30°F GLYCOL TEMP				
SUCTION PRESSURE @ 30°F GLYCOL TEMP.				
DISCHARGE PRESSURE @ 30°F GLYCOL TEMP.				
	PUMP #1	PUMP #2	PUMP #3	PUMP #4
MOTOR AMPS:	L1:	L1:	L1:	L1:
	L2:	L2:	L2:	L2:
	L3:	L3:	L3:	L3:
	FAN MOTOR #1	FAN MOTOR #2	FAN MOTOR #3	FAN MOTOR #4
MOTOR AMPS:	L1:	L1:	L1:	L1:
	L2:	L2:	L2:	L2:
	L3:	L3:	L3:	L3:
	FAN MOTOR #5	FAN MOTOR #6	FAN MOTOR #7	FAN MOTOR #8
MOTOR AMPS:	L1:	L1:	L1:	L1:
	L2:	L2:	L2:	L2:
	L3:	L3:	L3:	L3:
AMBIENT TEMP @ STARTUP				

## SEQUENCE OF OPERATION

1. Turn door power switch on.
2. Door power switch will energize thermostat when turned on.
3. Thermostat sends power to pump contactor coil & heater contactor.
4. When fluid reaches set point the thermostat stops sending power to the heater contactor and the heater turns off.

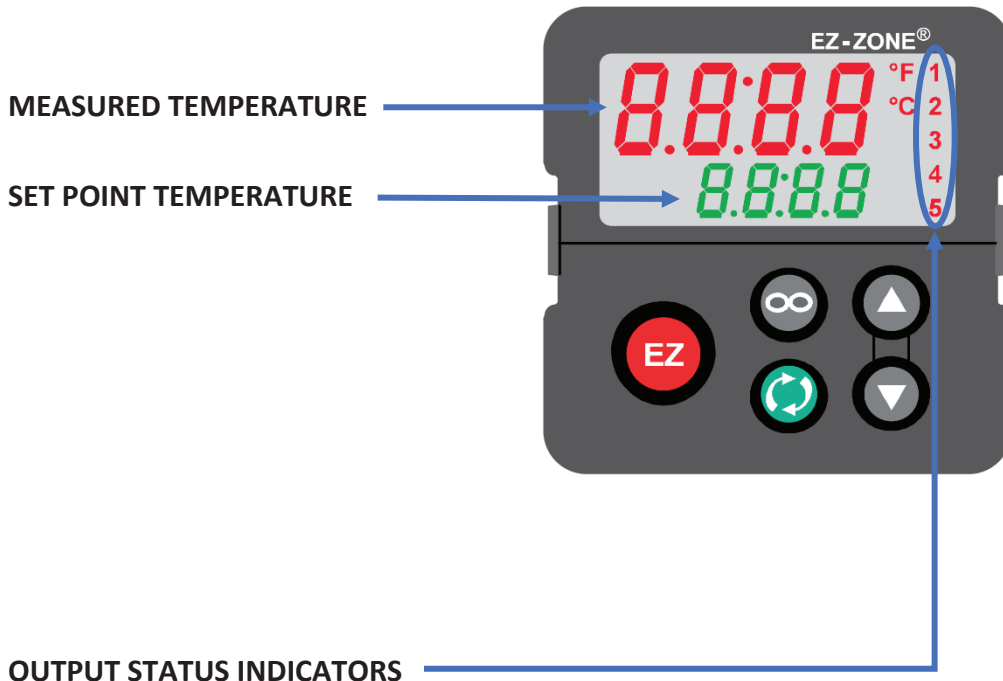

## MAINTENANCE

Please contact **G&D Technical Support** if you have any questions or concerns regarding the performance, operation, or maintenance of your heater: **800-555-0973**

- Refer to the separate G&D Chillers Preventive Maintenance Checklist for a complete list of maintenance tasks.
- Contract a licensed technician to evaluate the heater regularly. These checkups should occur annually at a minimum. Every 3-6 months is recommended.

**The heater requires minimal maintenance. Always verify that the glycol reservoir is at least  $\frac{3}{4}$  full prior to use, and that the level does not drop below half full while in operation.**

**The following tasks can be performed without the need for specialized equipment or training:**

- Check glycol level and glycol/water ratio monthly. Use glycol refractometer to confirm 35% glycol mixture.
- Verify pump function quarterly. Confirm glycol supply pressure. Listen for abnormal sounds from the pump.
- If not in use for long periods of time, the pumps should be started occasionally and fluid circulated to maintain proper seal lubrication.
- Verify thermostat function quarterly. Check displayed temperature against a thermometer measurement.
- Periodically inspect the power cord and control panel for any sign of failure (scorched or frayed wiring, moisture...). Cords or wiring cracked or worn insulation should be replaced immediately.
- See warning below. With the cord unplugged (no power to the heater), inspect control panel contacts on pump contactors. Contact an electrician if replacements are needed.

### **WARNING:**

**DO NOT ATTEMPT TO SERVICE ELECTRICAL COMPONENTS OR MAKE ADJUSTMENTS IN ELECTRICAL PANEL WITHOUT PROPER TRAINING AND IMPLEMENTATION OF LOCKOUT/TAG-OUT SAFETY PROCEDURES**

## TROUBLESHOOTING

G&D glycol heaters are robust and easy to use. The number of potential failure modes has been minimized by the simple design and few moving parts. If you notice any of the following mechanical issues, contact G&D Technical Support as soon as possible:

- Excessive or unusual noise
- Abnormally low pump pressure or noise from pump

### CONTROLLER ERRORS

Occasionally you may see an error message displayed on the controller, such as “AL.h1” or “Li.h1”. These are both errors related to overheating. If they appear it is usually because the limit has been set too low, or the heater was left running for an extended period of time with no load against it.

**AL.h1** – Fluid high temperature alarm

**Li.h1** – Heating element high temperature alarm

One possible cause for “Li.h1” is a low fluid level in the glycol reservoir. If this happens DO NOT operate the unit until glycol has been added to the system.

The “AL.h1” alarm occurs when the fluid temperature is 20 °F above the set point. Under normal operating conditions this alarm should not be present. However, when there is no load against the heater and it is left running, the pump can generate enough heat to increase the glycol temperature until “AL.h1” is triggered.

To avoid this issue, do not leave the heater on over the weekend or for prolonged periods of time without checking temperatures. Unplug the heater when not in use.

### CLEARING AN ERROR MESSAGE

If an error message is displayed, always attempt to determine the cause before clearing it. Contact G&D Technical Support for assistance. To clear an error:

- Press the green “Advance” key
- “i9nr” should be displayed in green
- Press the down arrow. “Clr” should appear
- Press the black “Reset” or “Infiniti” key to execute the command
- The error will blink once, then the controller will return to normal operation

\*Contact G&D Technical Support at 800-555-0973 before clearing controller errors\*

---

## PROPYLENE GLYCOL CHART

Percent by volume	Percent by weight	Freezing point °F	Degrees Brix °Bx
32.4	33.0	5.3	24.4
32.8	33.4	4.8	24.8
33.1	33.7	4.4	25.0
33.5	34.0	3.9	25.3
34.0	34.6	3.1	25.8
34.4	35.0	2.4	26.1
<b>35.0</b>	<b>35.6</b>	<b>1.5</b>	<b>26.5</b>
35.5	36.0	0.8	26.9
36.5	37.0	-0.8	27.5
37.5	38.0	-2.4	28.0
38.2	38.7	-3.7	28.4
38.5	39.0	-4.2	28.5

*For most applications, G&D Chillers recommends no less than and no more than 35% propylene mixture.*

*The volume percentages in this table apply for pure propylene glycol; however, inhibited propylene glycol solutions will require higher volume percentages. For example, a solution of 36.6%vol DOWFROST contains 35%vol pure propylene glycol. Use the refractometer included with the chiller to verify proper glycol concentration.*

---



**\*\*TO ACTIVATE WARRANTY, FILL OUT STARTUP CHECKLIST AND RETURN WITHIN 30 DAYS\*\***

## WARRANTY STATEMENT

### TWO-YEAR LIMITED WARRANTY ON PARTS, ONE-YEAR LIMITED WARRANTY ON LABOR

G&D CHILLERS, INC. provides a limited warranty to the original purchaser of new products against defects in materials and workmanship for a period of one (1) year of normal commercial usage. For the subsequent period of one (1) year of normal commercial usage immediately following the first, this warranty is extended to cover parts only. This warranty is not transferable. If a product covered by this warranty is determined to be defective within the applicable warranty periods, G&D CHILLERS, INC. will, unless otherwise required by applicable law, either repair or exchange the product at its sole option and discretion.

### EXCHANGE

Should G&D CHILLERS, INC. elect to exchange a product due to a covered defect during the warranty period, the replacement unit may, at G&D CHILLERS, INC.'s sole option and discretion, be new or one which has been recertified, reconditioned, refurbished or otherwise remanufactured from new or used parts and is functionally equivalent to the original product.

### REPAIR: PARTS AND LABOR

There will be no charge for parts or labor to repair a product for a covered defect during the applicable warranty periods. Replacement parts may, at G&D CHILLERS, INC.'s sole option and discretion, be new, used, reconditioned, refurbished or otherwise remanufactured or recertified as functionally equivalent replacement parts.

### REMAINING WARRANTY

Repaired or exchanged products are warranted for the remaining portion of the product's original warranty or for ninety (90) days from warranty service or exchange, whichever is longer. Any upgrade to the original product will be covered only for the duration of the original warranty period.

### EXCLUSIONS

This warranty does not cover, for example: abuse, accident, acts of God, consumable parts such as batteries, cosmetic damage (e.g. scratches, dents, cracks), damage caused by use with non-G&D CHILLERS, INC. products (e.g. accessories, housing, parts, etc.), damages from shipping, improper installation or operation, improper voltage supply or power surges, lack of reasonable use, misuse, modifications or alterations, normal wear and tear or aging, as well as installation and set-up issues or any tampering or repairs attempted by anyone other than by a G&D CHILLERS, INC. authorized repair technician. This limited warranty does not cover products sold "AS IS", "FACTORY RECERTIFIED", or by a non-authorized reseller.

### ASSIGNMENT OF WARRANTIES

G&D CHILLERS, INC. assigns to product purchasers any and all warranties of manufacturers and suppliers of component parts that are assignable, but G&D CHILLERS, INC. makes no representations as to the effectiveness or extent of such warranties and assumes no liability or responsibility for any third-party manufacturer or supplier's products or component parts that are sold by G&D CHILLERS, INC.

### DISCLAIMER OF WARRANTY

THERE ARE NO EXPRESS WARRANTIES OTHER THAN THOSE LISTED OR DESCRIBED ABOVE. EXCEPT AS SPECIFIED IN THIS WARRANTY SECTION, ALL EXPRESS OR IMPLIED CONDITIONS, REPRESENTATIONS, AND WARRANTIES INCLUDING, WITHOUT LIMITATION, ANY IMPLIED WARRANTY OR CONDITION OF MERCHANTABILITY, FITNESS FOR A PARTICULAR PURPOSE, OR ARISING FROM A COURSE OF DEALING, LAW, USAGE, OR TRADE PRACTICE, ARE HEREBY EXCLUDED TO THE EXTENT ALLOWED BY APPLICABLE LAW AND ARE EXPRESSLY DISCLAIMED BY G&D CHILLERS, INC.

---

TO THE EXTENT THAT ANY OF THE SAME CANNOT BE EXCLUDED, SUCH IMPLIED CONDITION, REPRESENTATION AND/OR WARRANTY IS LIMITED IN DURATION TO THE EXPRESS WARRANTY PERIOD REFERRED TO IN THE "LIMITED WARRANTY" SECTION ABOVE. BECAUSE SOME STATES OR JURISDICTIONS DO NOT ALLOW LIMITATIONS ON HOW LONG AN IMPLIED WARRANTY LASTS, THE ABOVE LIMITATION MAY NOT APPLY IN SUCH STATES. THIS WARRANTY GIVES THE CUSTOMER SPECIFIC LEGAL RIGHTS, AND THE CUSTOMER MAY ALSO HAVE OTHER RIGHTS WHICH VARY FROM JURISDICTION TO JURISDICTION.

### **DISCLAIMER OF LIABILITY**

G&D CHILLERS, INC.'S TOTAL LIABILITY FOR ANY AND ALL LOSSES AND DAMAGES RESULTING FROM ANY CAUSE WHATSOEVER INCLUDING G&D CHILLERS, INC.'S NEGLIGENCE, ALLEGED DAMAGE, OR DEFECTIVE GOODS, WHETHER SUCH DEFECTS ARE DISCOVERABLE OR LATENT, SHALL IN NO EVENT EXCEED THE PURCHASE PRICE OF THE PRODUCT. G&D CHILLERS, INC. SHALL NOT BE RESPONSIBLE FOR LOSS OF USE, WORK STOPPAGE, FAILURE OF OTHER EQUIPMENT TO WHICH THE PRODUCT IS CONNECTED, COMMERCIAL LOSS, LOST REVENUE OR LOST PROFITS, LOSS OF GOODWILL, LOSS OF REPUTATION, OR OTHER INCIDENTAL OR CONSEQUENTIAL DAMAGES. NO ORAL OR WRITTEN REPRESENTATIONS MADE BY G&D CHILLERS, INC. SHALL CREATE ANY ADDITIONAL WARRANTY OBLIGATIONS, INCREASE THE SCOPE, OR OTHERWISE MODIFY IN ANY MANNER THE TERMS OF THIS LIMITED WARRANTY. TO THE EXTENT PERMITTED BY APPLICABLE LAW, G&D CHILLERS, INC. DOES NOT WARRANT THAT THE OPERATION OF ANY PRODUCTS COVERED UNDER THIS LIMITED WARRANTY WILL MEET YOUR REQUIREMENTS, OR THIRD PARTY SERVICES, BE UNINTERRUPTED, ERROR-FREE, OR THAT DEFECTS IN THE PRODUCTS WILL BE CORRECTED. SOME STATES DO NOT ALLOW THE EXCLUSION OF INCIDENTAL OR CONSEQUENTIAL DAMAGES, SO THE ABOVE LIMITATIONS OR EXCLUSIONS MAY NOT APPLY TO YOU. THIS WARRANTY GIVES YOU SPECIFIC LEGAL RIGHTS, AND YOU MAY ALSO HAVE OTHER RIGHTS, WHICH VARY FROM STATE TO STATE. THIS LIMITED WARRANTY IS SUBJECT TO CHANGE WITHOUT NOTICE. CHECK [www.gdchillers.com](http://www.gdchillers.com) FOR THE MOST CURRENT VERSION OF THIS WARRANTY.

### **SEVERABILITY**

In the event that any term or provision contained in this limited warranty is found to be invalid, illegal or unenforceable by a court of competent jurisdiction, then such provision shall be deemed modified to the extent necessary to make such provision enforceable by such court, taking into account the intent of the parties. The invalidity in whole or in part of any portion of this limited warranty shall not impair or affect the validity or enforceability of the remaining provisions of this limited warranty.

### **HOW TO OBTAIN WARRANTY SERVICE (PRE-AUTHORIZATION REQUIRED)**

To obtain warranty service, contact G&D CHILLERS, INC.:

1. Email: [info@gdchillers.com](mailto:info@gdchillers.com)
2. Phone: (800) 555-0973 from 9:00AM to 5:00PM Monday through Friday Pacific Time.
3. By mail: G&D Chillers, Inc.  
130 E. 1st Ave  
Junction City, OR 97448



G&D Chillers welcomes any and all questions or concerns  
We can be reached at 800-555-0973 or 541-345-3903