



FIRE & ICE MODEL: CH-3/25

230 Volt 1 Phase	
FLA	-
MCA	-
MOC	-

230 Volt 3 Phase	
FLA	-
MCA	-
MOC	-

460 Volt 3 Phase	
FLA	34
MCA	43
MOC	45

Dimensions	32"W x 52"L x 45"H
Frame	Powder Coated Steel
Housing	Stainless Steel
Tank	30 Gallon Stainless Steel
Compressor	3 HP
Condenser	Air-Cooled
Glycol Pump	1.5 HP
Process Flow	40 GPM @ 25 PSI
Connection Size	0.75" Brass Quick Connects (x4)
Heat Exchanger	Stainless Steel Brazed Plate
Controls	Single Stage Digital

Heating Element	25 kW
Electrical Enclosure	NEMA 3R
Ship/Operating Weight	750/1000 lbs
Decibels @ 10'	62 dBA
Refrigerant	R448A
Cooling Capacity ¹	21,800 Btu/h
Heating Capacity	85,300 Btu/h

1. Capacity with 30 °F glycol LFT in 90 °F ambient

2. Specifications subject to change without notice

Fire & Ice package consists of the following:

- Complete refrigeration circuit
- Air-cooled condenser
- Glycol pump
- Fluid bypass valve
- Freeze stat safety switch
- Digital temperature controller
- All insulated copper piping
- Stainless steel housing
- Powder coated steel frame
- Insulated stainless steel glycol reservoir
- Low watt density heating element specifically designed for glycol
- Engineered high efficiency heat exchanger for maximum energy savings
- Heavy duty rubber-on-steel casters for easy portability
- Brass quick connects for temperature control of up to 4 tanks at once without loss of glycol
- Complete set of 20 ft. glycol hoses and 25 ft. power cord
- ETL (UL508) listed complete control panel with single point electrical connection, breakers, starters & safety switches
- Louvered stainless steel access panels for easy service & maintenance
- Factory run tested and fully charged with refrigerant

2 Year Parts and 1 Year Labor Warranty

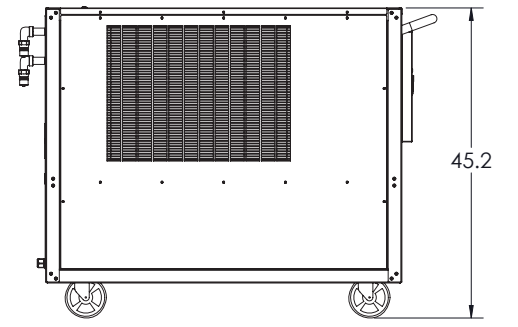
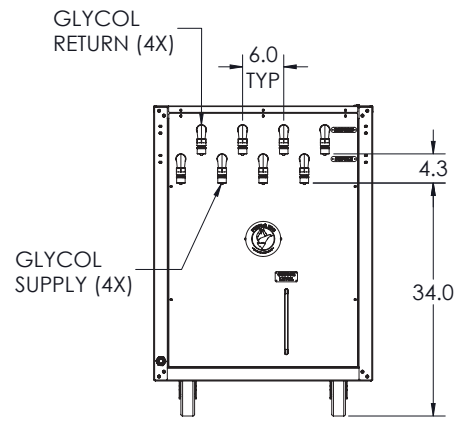
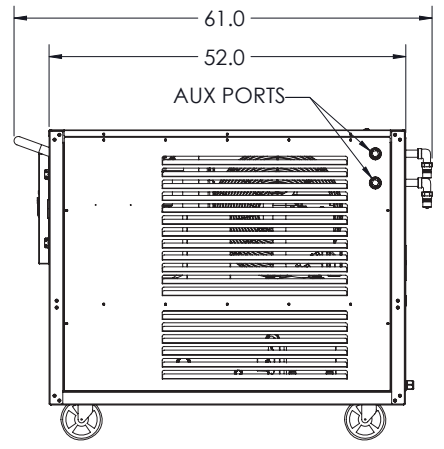
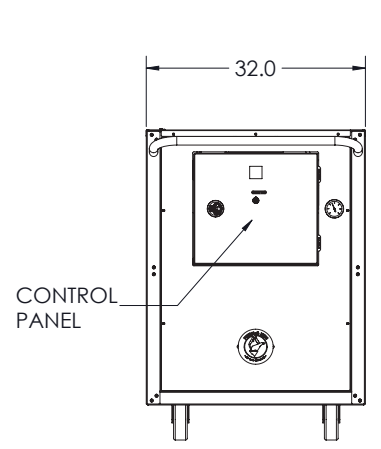
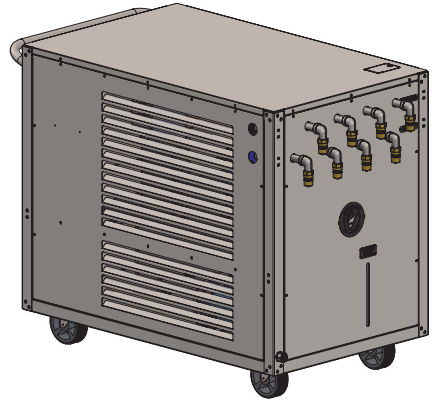
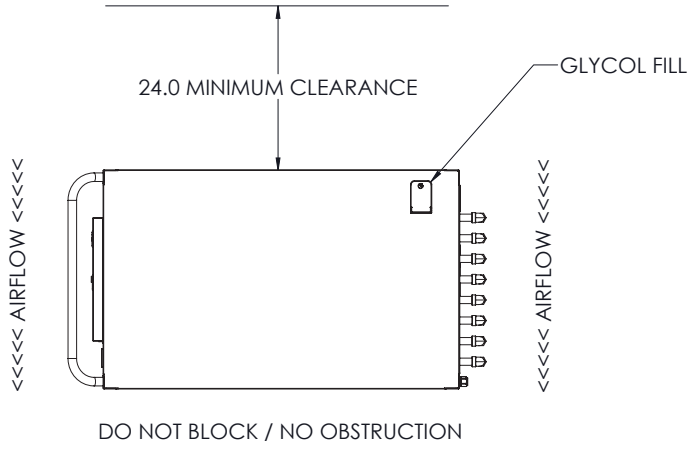

FIRE & ICE

PORTABLE CHILLER & HEATER

DRAWN:	AH
APPROVED:	TH
REVISION DATE:	05/11/23

G&D CHILLERS
 COMMITTED TO COLD

130 E FIRST AVE, JUNCTION CITY, OR 97448
 TEL: (541) 345-3903 (800) 555-0973