



CHILLER MODEL: GD-50T-2 HVAC

208-240V 1 Phase	
FLA	-
MCA	-
MOC	-

208-240V 3 Phase	
FLA	251
MCA	279
MOC	350

460-480V 3 Phase	
FLA	128
MCA	142
MOC	175

Dimensions ¹	45"W x 167"L x 108"H
Frame & Housing	Powder Coated Steel
Compressor	Tandem Scroll
Condenser	Air-Cooled Vertical Discharge
Connection Size	3" CTS Flange
Heat Exchanger	Stainless Steel Brazed Plate
Controls	Microprocessor w/ Comm.
Electrical Enclosure	NEMA 3R
Ship/Operating Weight	4600/7800 lbs
Decibels @ 10'	77 dBA
Refrigerant	R454B

Cooling Capacity by Leaving Fluid Temperature²

LFT	Btu/H	kW
44°F	589,400	172.7

1. Package chiller dimensions, remote condenser options will vary

2. Capacities based on 10°F temperature difference and 90°F ambient at 0' ASL

3. Specifications subject to change without notice

Chiller package consists of the following:

- Complete refrigeration circuit
- Tandem scroll compressors
- Air-cooled condenser
- Freeze stat safety switch
- All insulated copper piping
- ASME B16.5 flange connections
- Powder coated steel frame and housing
- Engineered high efficiency heat exchanger for maximum energy savings
- Microprocessor controller with communication
- ETL (UL508) listed complete control panel with single point electrical connection, breakers, starters & safety switches
- Removable access panels for easy service & maintenance
- Factory run tested and fully charged with refrigerant

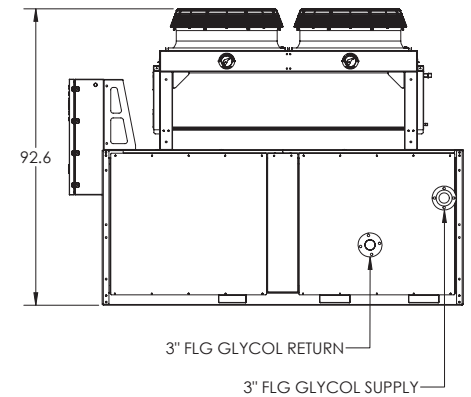
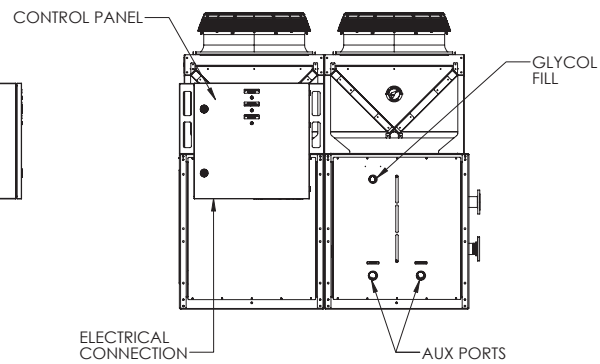
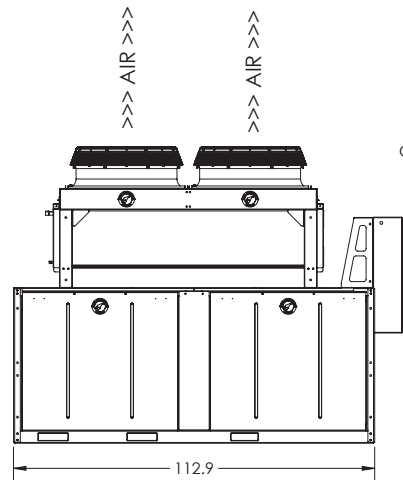
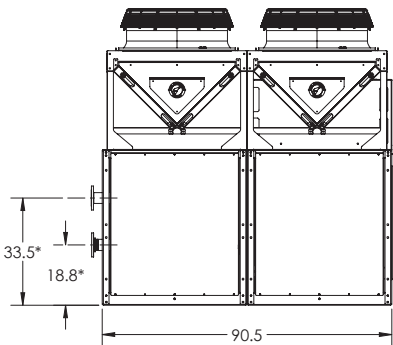
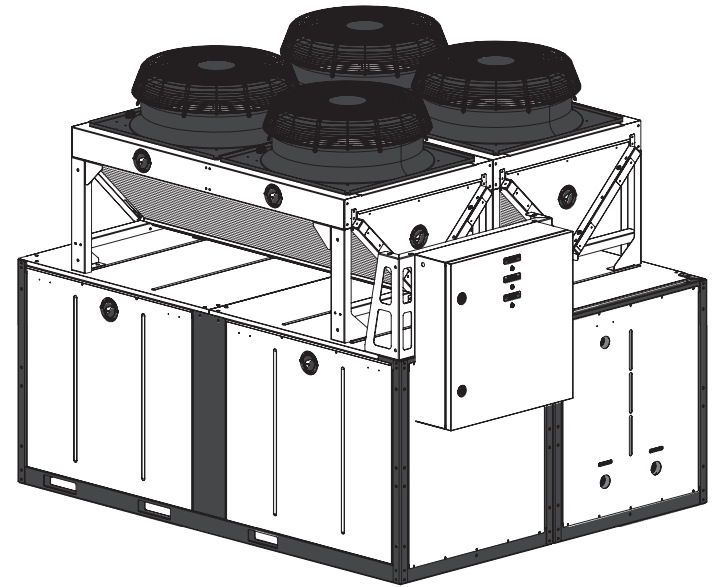
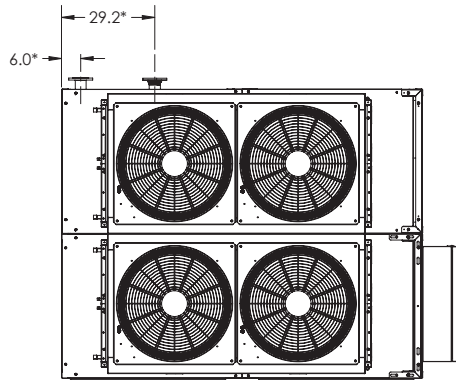

1. ASTERISK * INDICATES APPROXIMATE DIMENSIONS, DO NOT USE TO PREFABRICATE CONNECTING PIPING
2. ENSURE A MINIMUM OF 8 FT CLEARANCE AROUND ALL SIDES OF UNIT
3. UNIT MUST BE SECURELY ANCHORED TO A FLAT AND LEVEL PAD
4. ALL DIMENSIONS MEASURED IN INCHES
5. INSTALLATION OF ELECTRICAL SERVICE
 - A. POWER WIRING TO TERMINATE AT DISTRIBUTION BLOCKS INSIDE ENCLOSURE
 - B. PENETRATIONS TO BE DRILLED IN FIELD BY OTHERS THROUGH BOTTOM OF ENCLOSURE
 - C. USE ONLY CONDUIT/FITTINGS WITH SAME (OR HIGHER) ENVIRONMENTAL RATING AS ENCLOSURE
 - D. FIELD-INSTALLED EXTERNAL DISCONNECT TO BE PROVIDED BY OTHERS

GD-50T-2

VERTICAL AIR CHILLER

DRAWN:	LL
APPROVED:	XX
DATE:	05/28/26



G&D CHILLERS
COMMITTED TO COLD

130 E FIRST AVE, JUNCTION CITY, OR 97448
TEL: (541) 345-3903 (800) 555-0973